

Projekt:
70cm VCO mit MAX2608
 Datei: 430MHz VCO_MAX2608_V1a.SchDoc

Tomtom
DL1MFK
 Datum: 16.01.2010
 Uhrzeit: 18:22:47
 Rev.: C

DL1MFK 01/10
70cm VCO

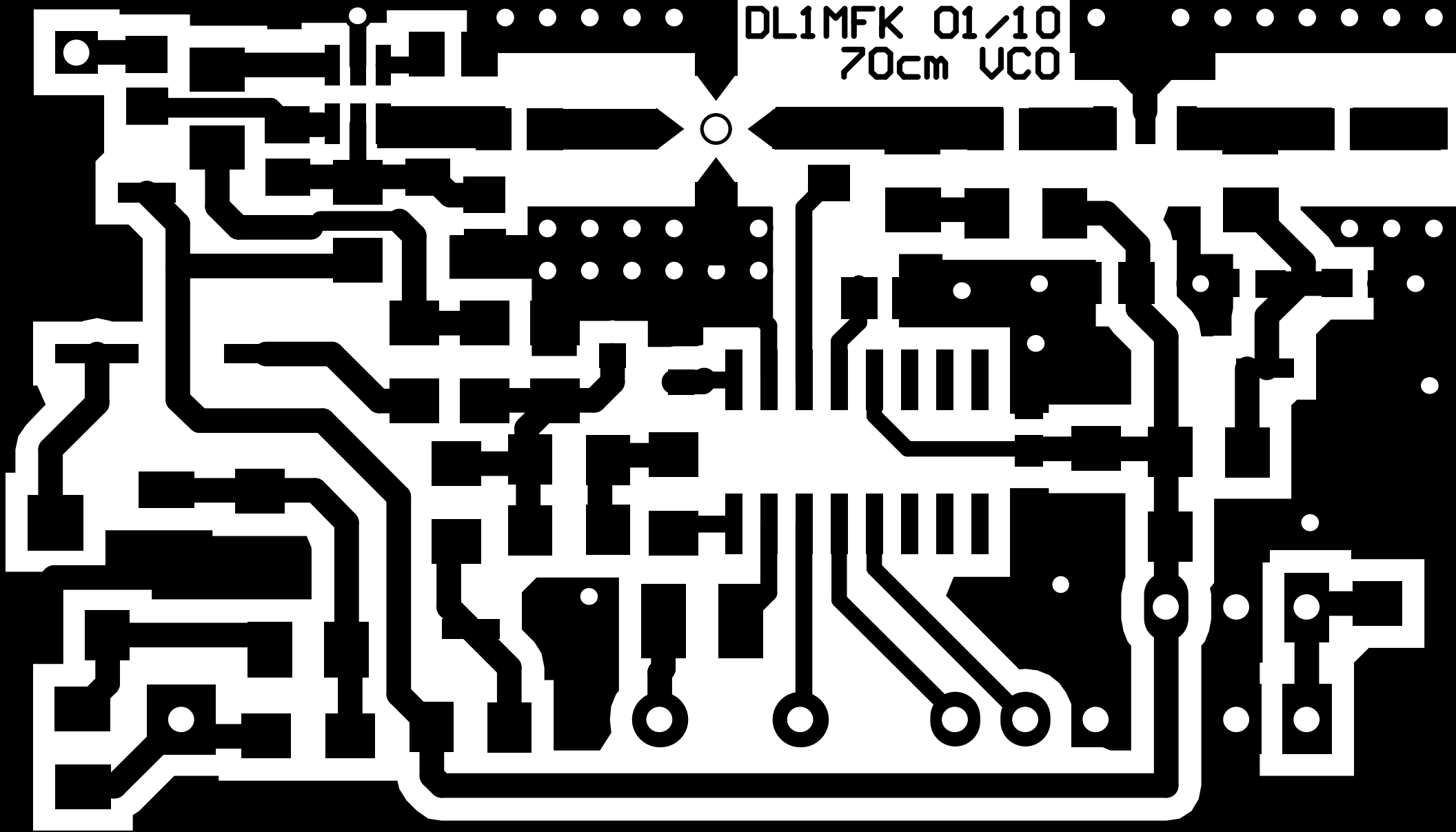

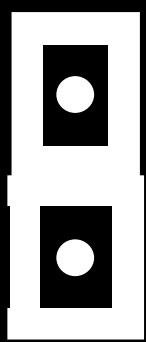
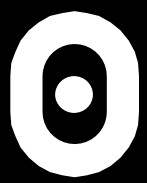
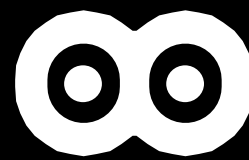
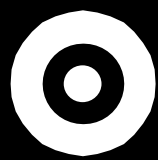
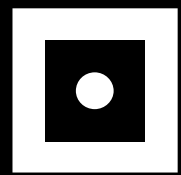
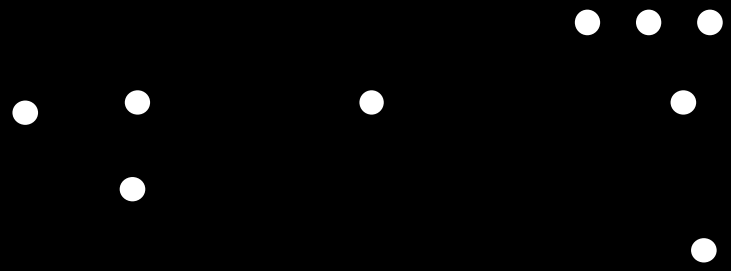
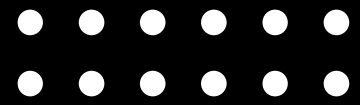
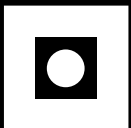
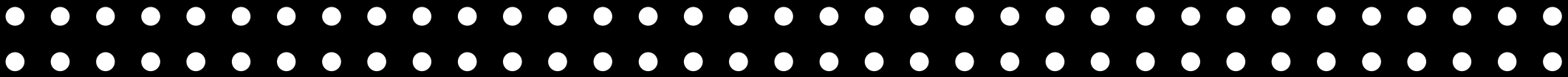

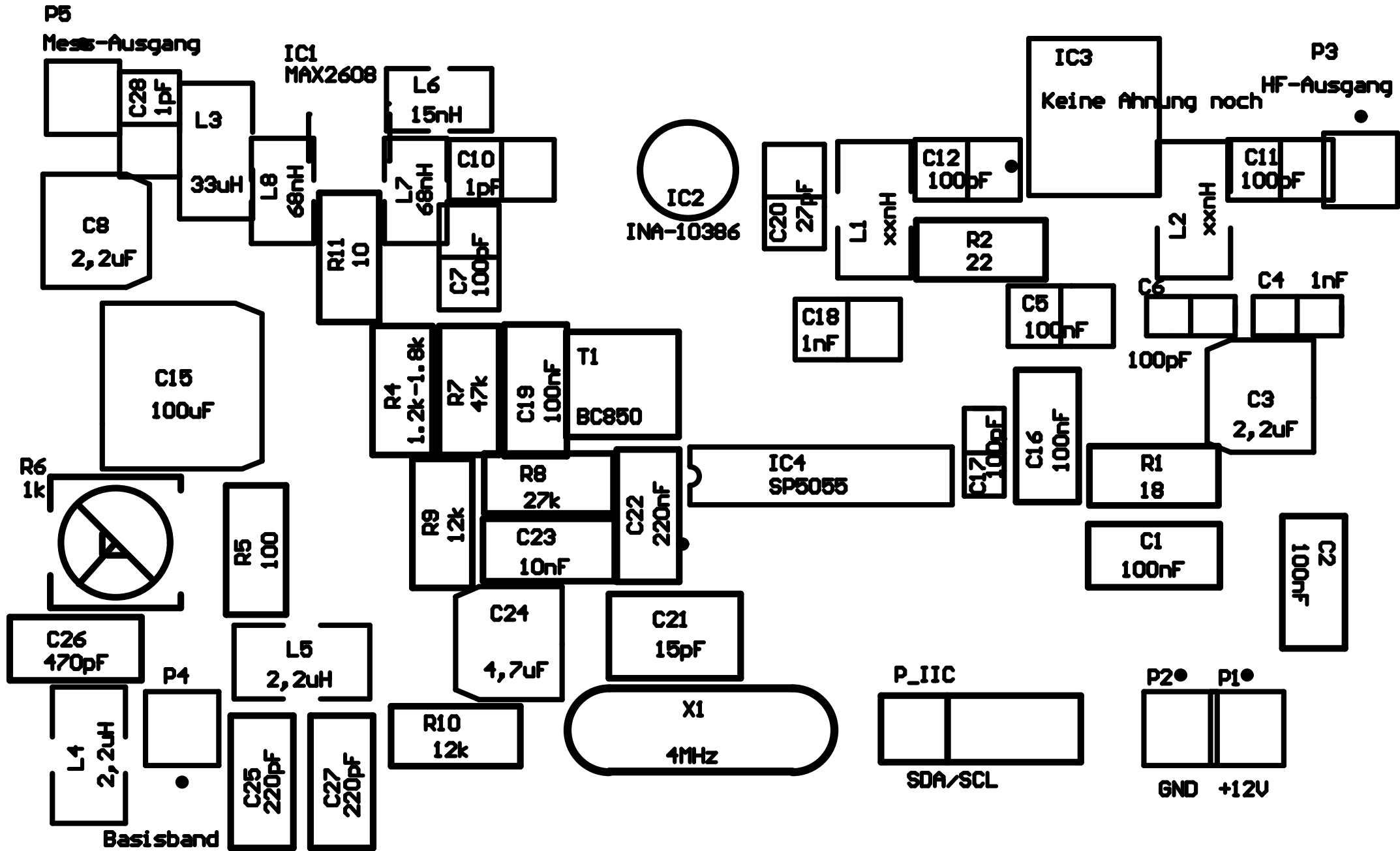

2082		
3	5	1

Volt Red